



Truss+ 2010

Truss Database Manager

Starting Truss Database Manager

- Two ways to run Truss database manager:
 - By choosing *Truss Database Manager* directly from “Truss+” menu;
 - By choosing *Truss database* from the ‘Truss system configuration’ window.

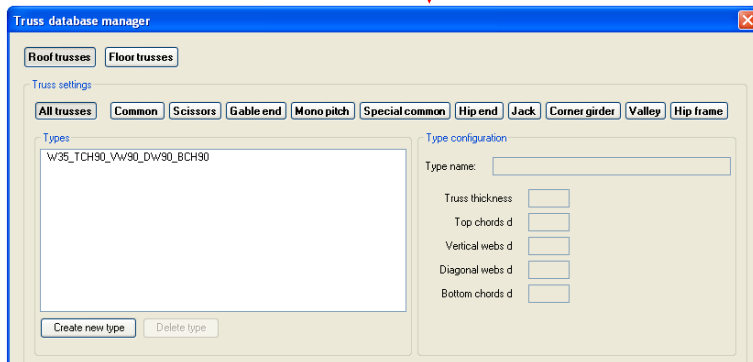
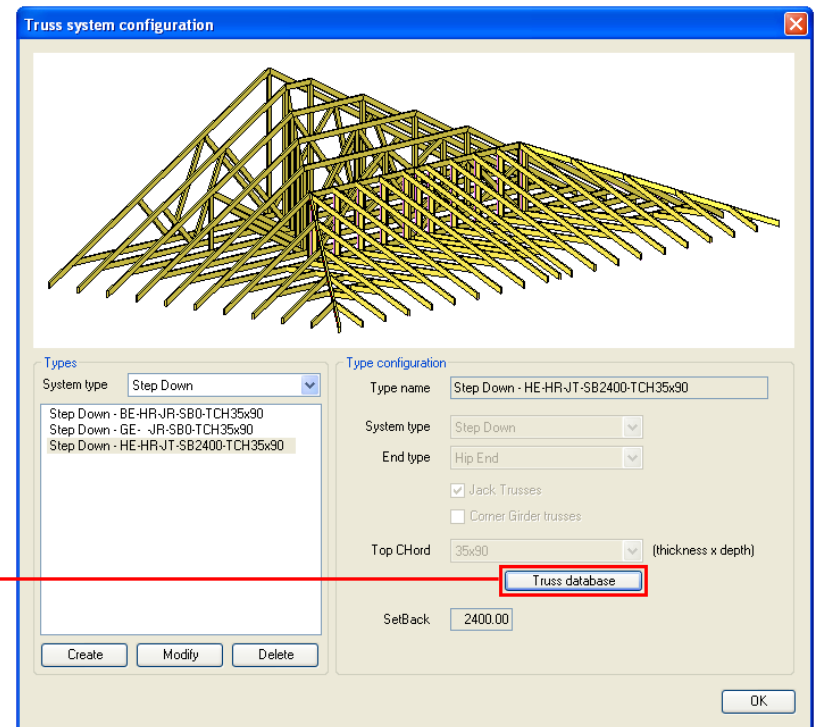
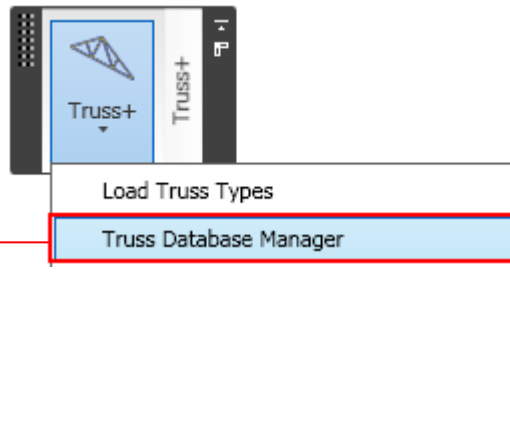

Parameters

- The meaning of type configuration values is shown in pictures.

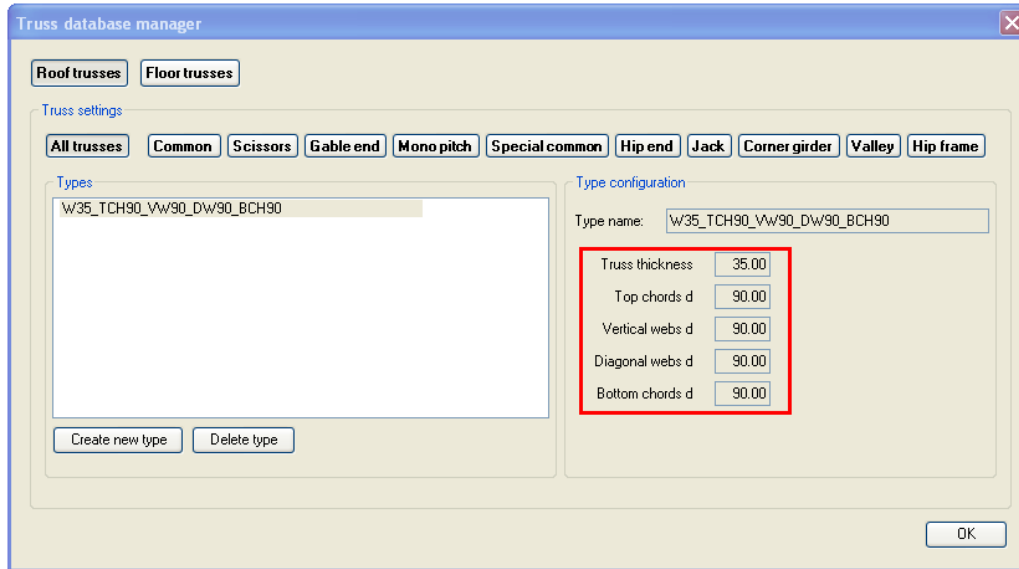

Side view

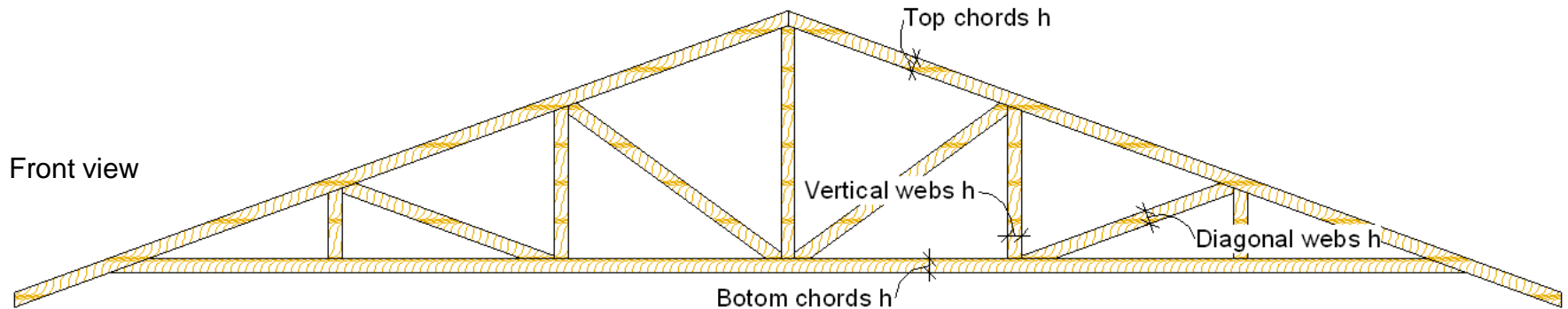
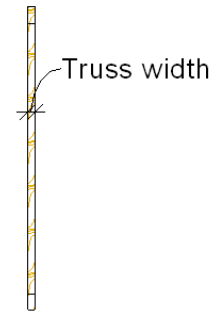

Front view

Creating New Types

- In tab 'All trusses' click the button *Create new type*.
- Fill all parameters and click the *Create* button.
- 'Type name' will represent all parameters that you set for your new truss type.

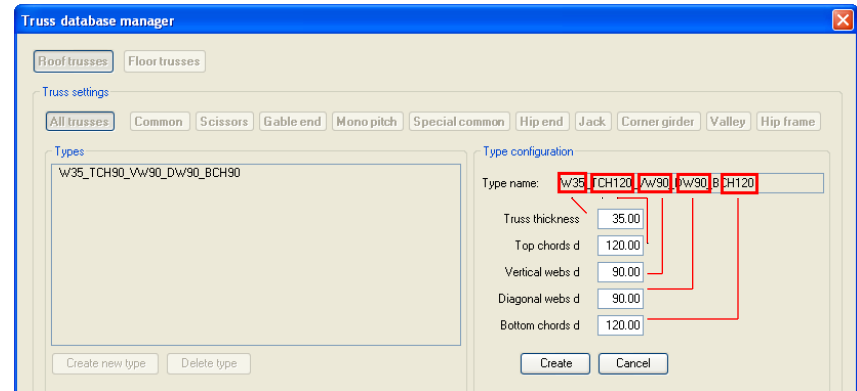
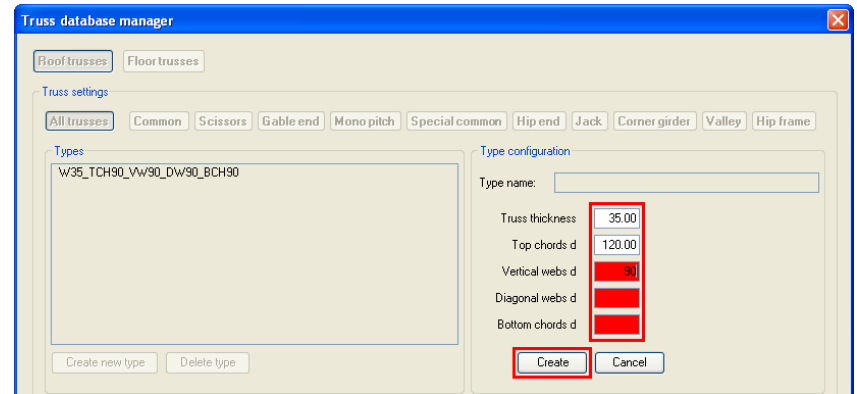
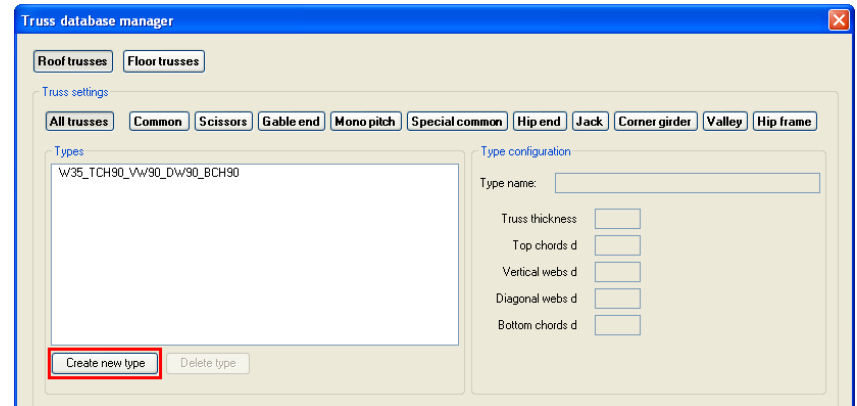

Deleting Types

- If you want to delete a truss type, that doesn't meet your regional defaults, click the *Delete type* button.

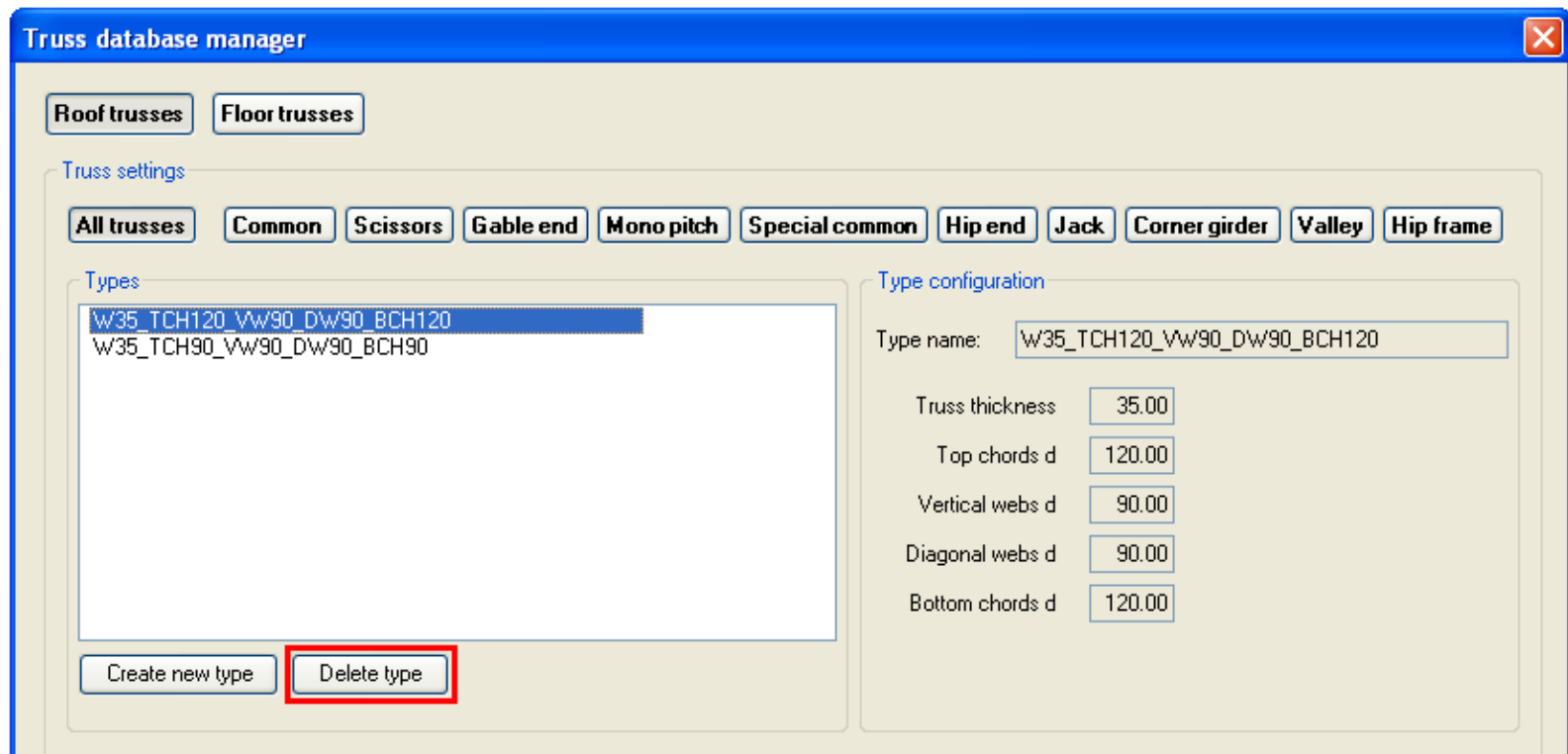

Notes

- Make sure that all truss categories (classes) have the same types.
- If at least one of the truss categories has less types, in tab 'All trusses' name of this type will contain note **“not in all families”**.

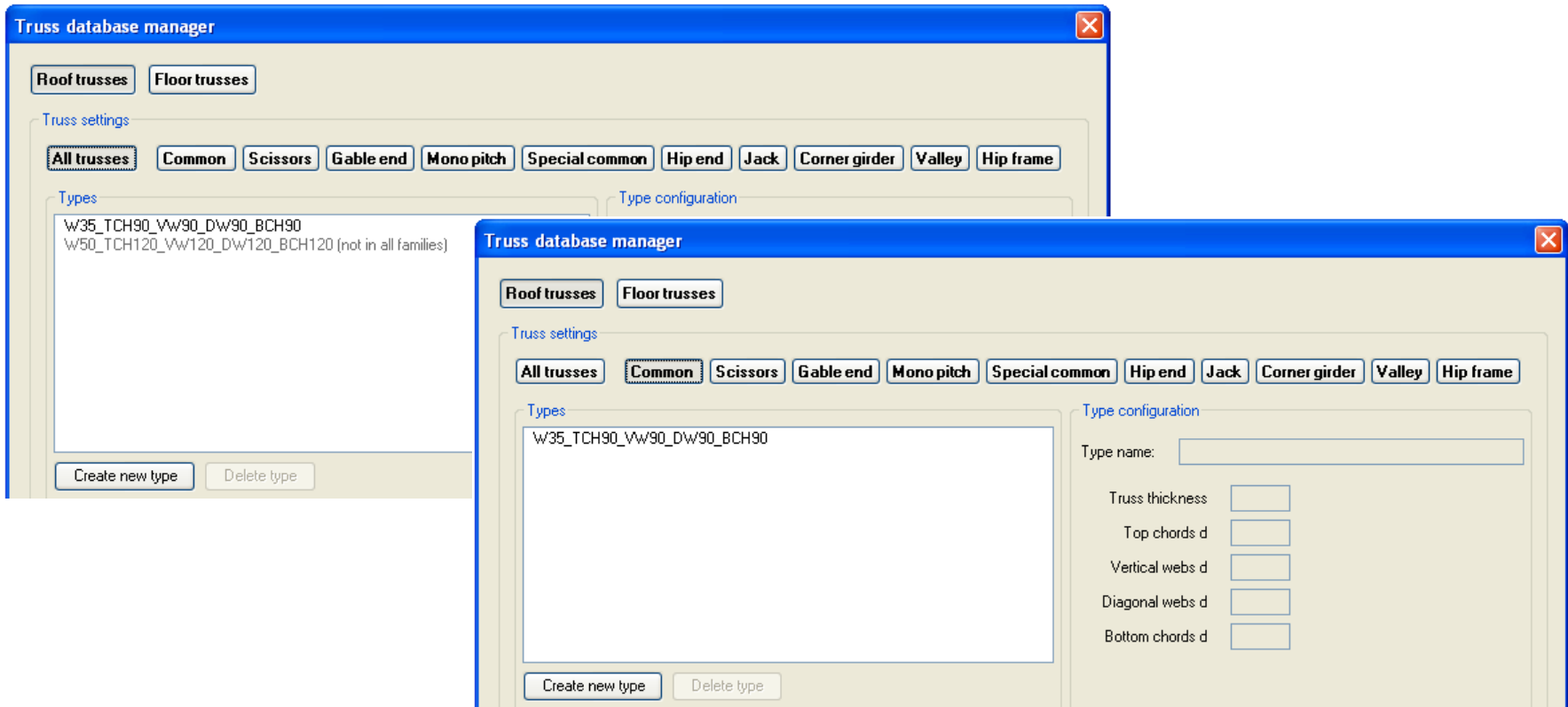

Notes

- Three options to avoid this:
 - Delete that type of truss one by one from all categories using the command *Delete type*;
 - Delete that type of truss from all categories by one click. Use the command *Delete type* in tab 'All trusses';
 - Create that type of truss in all categories using the command *Create missing types* in tab 'All trusses'.

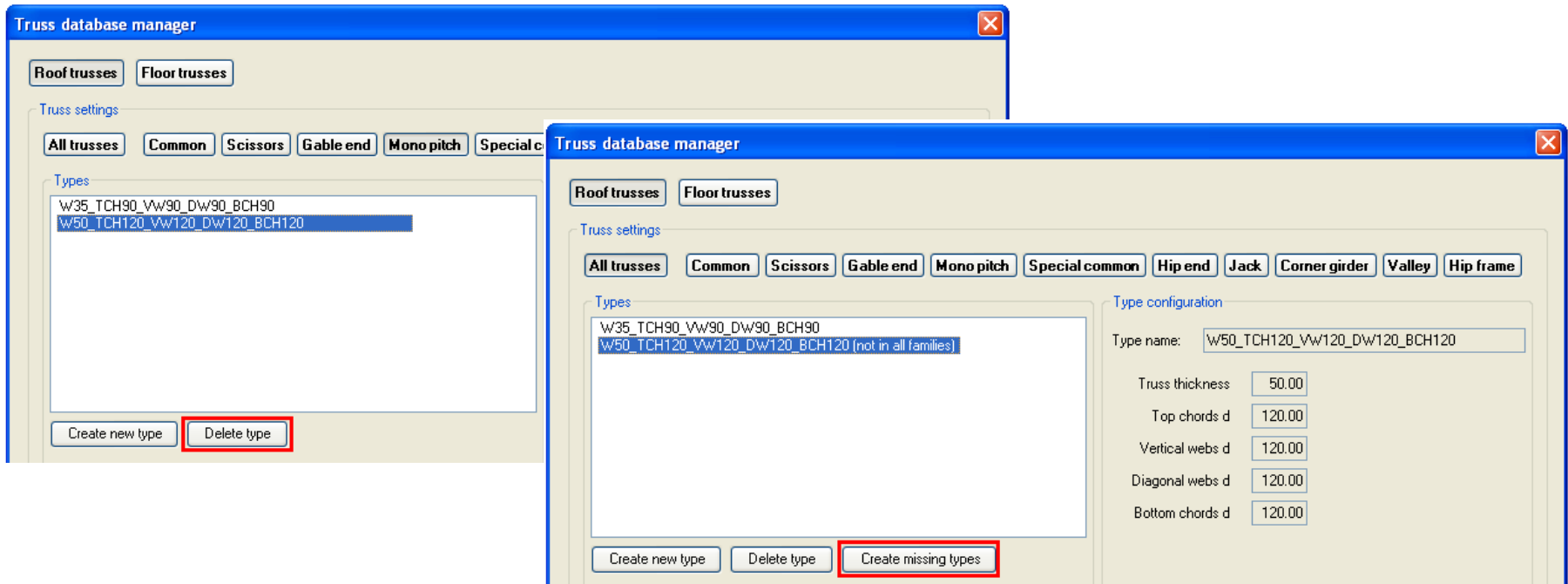

Increase your productivity !



AGA CAD Ltd.
Zalgirio 112A, LT-09300 Vilnius,
Lithuania
Tel. +370 5 2398111
Fax +370 5 2398113
Email info@aga-cad.lt
info@tools4revit.com
www.tools4revit.com